

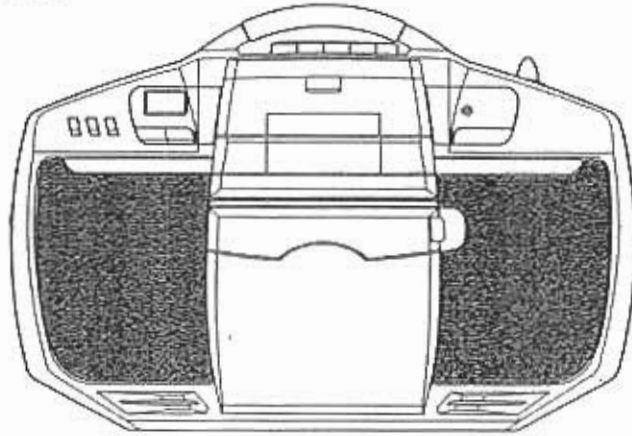

PORTABLE CD SYSTEM OPERATION INSTRUCTION

COMPACT
disc
DIGITAL AUDIO



 <p>The lightning flash and arrowhead within the triangle is a warning sign alerting you of "dangerous voltage" inside the product.</p>	<p>WARNING RISK OF ELECTRIC SHOCK DO NOT OPEN</p> <p>WARNING: TO REDUCE THE RISK OF ELECTRIC SHOCK, DO NOT REMOVE COVER (OR BACK) NO USER-SERVICEABLE PARTS INSIDE. REFER SERVICING TO QUALIFIED SERVICE PERSONNEL.</p>	 <p>The exclamation point within the triangle is a warning sign alerting you of important instructions accompanying the product.</p>
--	---	---

WARNING: TO REDUCE THE RISK OF FIRE OR ELECTRIC SHOCK, DO NOT EXPOSE THIS APPLIANCE TO RAIN OR MOISTURE
CLASS 1 LASER PRODUCT

**CLASS 1 LASER
PRODUCT
APPAREIL À LASER DE
CLASSE 1**

CAUTION
INVISIBLE LASER RADIATION WHEN
OPEN AND INTERLOCKS DEFEATED.
AVOID EXPOSURE TO BEAM



This product contains a low power laser device.

SAFETY PRECAUTIONS

Follow the advice below for safe and appropriate operations.

ON PLACEMENT

- Do not use the unit in places which are extremely hot, cold, dusty or humid.
- Place the unit on a flat and even surface.
- Do not restrict the air flow of the unit by placing it in a place with poor air flow, by covering it with a cloth, or by placing it on a carpet.

ON SAFETY

- When connecting and disconnecting the AC cord, grip the plug and not the cord itself. Pulling the cord may damage it and create hazard.
- When you are not going to use the unit for a long period of time, disconnect the AC power cord.

ON AC VOLTAGE

- Before use, check that the rated voltage of your unit matches your local voltage.
- When there is condensation inside the unit, the unit may not function normally.
- Let it stand for 1 to 2 hours before turning the power on, or gradually heat the room up and dry the unit before use.

FCC INFORMATION

This device complies with part 15 of FCC Rules. Operations are subject to the following two conditions:

- (1) This device may not cause harmful interference, and
- (2) This device must accept any interference received, including interference that may cause undesirable operations.

Should any trouble occur, disconnect the AC power cord and refer servicing to qualified personnel.

NAMES OF CONTROLS

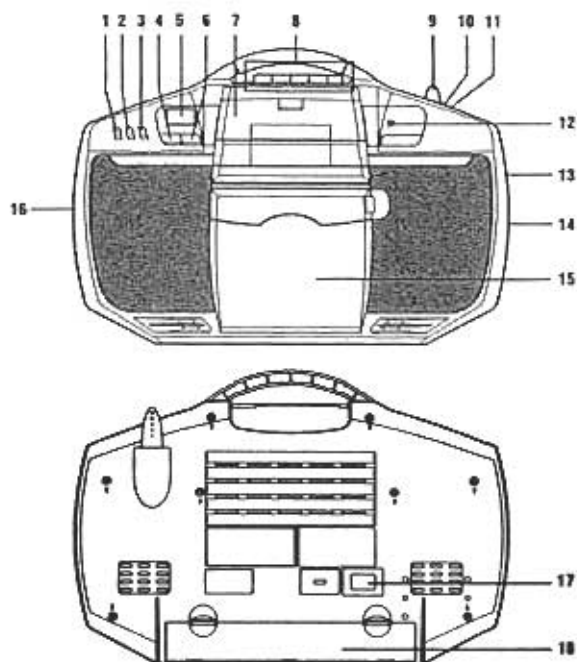

- | | |
|---|--|
| <ol style="list-style-type: none"> 1. REPEAT/PROGRAM button 2. SKIP (reverse) button 3. SKIP (forward) button 4. PLAY/PAUSE button 5. CD display <div style="border: 1px solid black; padding: 5px; margin: 5px 0;"> <p style="text-align: center;">Track number</p> <p>Play "●" indicator
 Pause "⏸" indicator
 Repeat all "●●" indicator
 Repeat one "●●" indicator</p> </div> <ol style="list-style-type: none"> 6. STOP button 7. Cassette compartment | <ol style="list-style-type: none"> 8. Cassette deck operation controls <ul style="list-style-type: none"> ■ STOP button ◀ F.FWD button ▶▶ REW button ▶ PLAY button ● REC button 9. Antenna 10. TUNING control 11. Dial scale 12. PROGRAM indicator 13. FUNCTION switch (Tape/Radio/CD) 14. BAND switch 15. CD door 16. VOLUME control 17. AC socket 18. Battery compartment |
|---|--|

POWERING UP

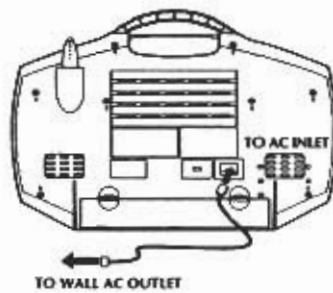

AC POWER

You can power your portable stereo system by plugging the detachable AC power cord into the AC inlet on the back of the unit and into a wall AC power outlet.

Check that the rated voltage of your unit matches your local voltage. Make sure that the AC power cord is fully inserted into the unit.

Caution: To prevent electrical shock, match wide blade of plug to wide slot, fully insert.

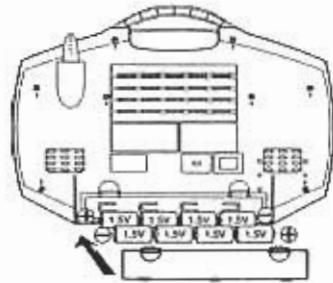

BATTERY POWER

Insert 8 "C" size batteries in the battery Compartment. Be sure that the batteries are inserted correctly to avoid damage to the unit. Always remove the batteries when unit will not be used for a long period of time, as this will cause leakage to the batteries and subsequently damage to your set.

ADJUSTING THE SOUND

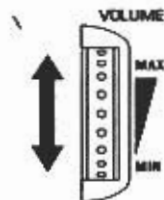

- Adjust the Volume.

WHEN RECORDING

The VOLUME control may be adjusted with no effect on the recorded signal.

⏮ SKIP ⏭

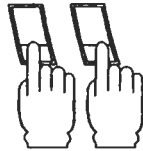

Each press skips one track

TO SKIP TO THE BEGINNING OF A TRACK

- Press either one of the ⏮ or ⏭ (skip) button according to the desired direction. Each press skips one track. During play, the first press on the skip backwards button (⏮) skips to the beginning of the current track.
- Playback resumes from the selected track.

⏮ SKIP ⏭

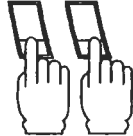

Keep it pressed during play

TO SEARCH THROUGH TRACKS

- Search function is possible only in playback mode.
- Keep either one of the ⏮ or ⏭ (skip) button pressed, according to the desired direction, and release at the desired point.

PROGRAM PLAY (IN STOP MODE)

1. Press the PROGRAM/REPEAT button. The PROGRAM indicator blinks and "0" flashes in the CD display.



2. Press the (⏮ / ⏭) SKIP button until the desired track appears on the CD display.

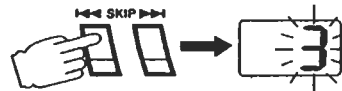

3. Press the PROGRAM/REPEAT button to register track no.3, for example, as the first selection. The track no. indication will be returned to "0".

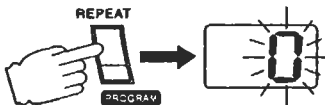

4. Repeat steps 2 and 3 until all the desired tracks are programmed (up to 19 tracks).

5. Press (▶||)PLAY/PAUSE button. During program playback, the PROGRAM indicator blinks.
NOTE: Programming can only be done when the unit is in the stop mode.

TO CHECK WHAT HAS BEEN PROGRAMMED

1. Press the PROGRAM/REPEAT button. The program indicator blinks.
2. Press (▶||)PLAY/PAUSE button.
3. Press the (▶▶)SKIP button.

TO CLEAR THE PROGRAM

- Set the FUNCTION switch to TAPE or RADIO.
- OR**
- Open the CD door (during stop mode).

REPEAT PLAY (IN PLAY MODE)



This function allows one track, all tracks on a disc or the programmed tracks only to be played repeatedly.

	<p>TO REPEAT THE SAME TRACK</p> <ul style="list-style-type: none"> • Press the PROGRAM/REPEAT button once during playback, the repeat indicator will blink.
	<p>TO REPEAT THE WHOLE DISC OR PROGRAMMED TRACKS</p> <ul style="list-style-type: none"> • Press the PROGRAM/REPEAT button a second time to repeat all tracks, the repeat indicator will light.
	<p>TO CANCEL REPEAT PLAY</p> <ul style="list-style-type: none"> • Press the REPEAT button until the repeat indicator is turned off. <p>NOTE: Repeat play can only be done when the unit is in the play mode.</p>

Note: After listening, set the FUNCTION switch to TAPE.

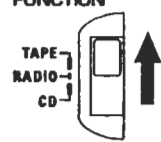
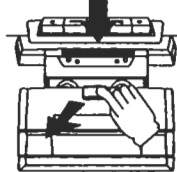
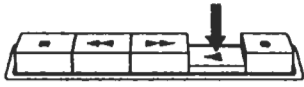
USING THE CASSETTE COMPARTMENT

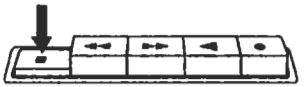
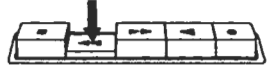
<p>1</p> <p>FUNCTION</p>  <p>TAPE RADIO CD</p>	<p>TAPE PLAYBACK</p> <p>1. Set the FUNCTION switch to TAPE.</p>
<p>2</p> 	<p>2. Insert a cassette tape.</p>
<p>3</p> 	<p>3. Press the (▶) PLAY button.</p>

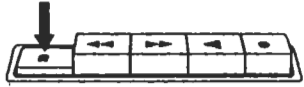
	<p>TO STOP PLAYBACK</p> <ul style="list-style-type: none">● Press the (■) STOP button.
 <p>OR</p> 	<p>TO FAST WIND</p> <ul style="list-style-type: none">● Press the (◀◀) F.FWD or (▶▶) REWIND button.
	<ul style="list-style-type: none">● Press the (■) STOP button to stop winding at the desired position.

CARE & MAINTENANCE

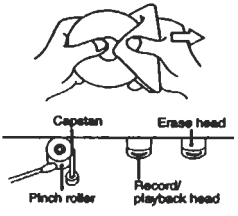

CLEANING CD
If the CD skips or will not play, the disc may need cleaning. Before playing, wipe the disc from the centre out with a cleaning cloth. After playing, store the disc in its case.

CLEANING THE TAPE HEADS
Clean the head with a cotton bud slightly moistened with cleaning fluid or denatured alcohol.

CLEANING THE UNIT
Do not use volatile chemicals on this unit. Clean by lightly wiping with a soft cloth.

IMPORTANT NOTICE:

- Should the CD door be opened before the reading of the CD is completed, a jamming noise may occur. This can be resolved by closing the CD door and then setting the FUNCTION switch temporarily to TAPE.
- If an abnormal display indication or an operating problem occurs, disconnect the AC power cord and remove the batteries. Wait at least 5 seconds, then reconnect the AC power cord or reinstall the batteries.

TROUBLE SHOOTING TIPS

	Problem	Solutions
CD	System does not turn on	<ul style="list-style-type: none"> • Make sure AC power plug is secure in the outlet, and outlet has power. • Batteries may be dead. Install new batteries. • Make sure FUNCTION switch is set to CD. • Make sure disc label is facing up. • Make sure disc is clean. • Pause mode is activated. • Disc may be damaged or dirty; check disc. • Make sure the unit is on a secure spot. Vibration or jarring can cause the disc to skip.
	Disc in place but unit won't play	
	Disc skips	
RADIO	Poor FM reception	<ul style="list-style-type: none"> • Electrical interference in your home can cause poor reception. Move the unit away from sources of interference (especially those with motors and transformers). • Reposition or turn the unit for better reception.
	Poor AM(MW) reception	
TAPE	Distorted or noisy recording	<ul style="list-style-type: none"> • Tape heads are dirty; clean them. • Tape is damaged. Try another tape. • Tabs on edge of cassette may be missing or broken. If you want to record on that cassette, cover the holes with removable tape.
	Record button won't depress	

RECORDING

USE ONLY NORMAL (TYPE I) TAPE FOR RECORDING.

1

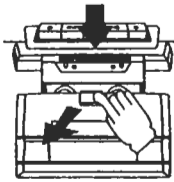

1. Insert a cassette tape.

2

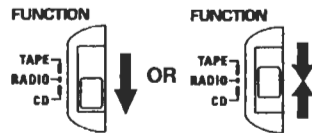

2. Prepare the source to be recorded and play it.
Recording from a CD
(Refer to CD play)
OR
Recording from the radio
(Refer to radio operation)

3



3. Press the (●) RECORD button.
Recording starts immediately.
The (◀) PLAY button is depressed automatically.

TO STOP RECORDING

Press the (■) STOP button.

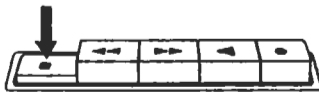

WHEN THE END OF THE TAPE IS REACHED

The tape stop and the buttons are released. To record on the other side, turn the cassette over and press the (●) RECORD button again.

TO ERASE A RECORDED TAPE

1. Set the function switch to TAPE.
2. Insert a tape with the side you want to erase facing you.
3. Press the ● RECORD button to start erasing.

SPECIFICATION

GENERAL

Power consumption: 10 W
Power source: AC 120V ~ 60 Hz (USA and Canada)
AC 230V ~ 50 Hz (Europe)
AC 240V ~ 50 Hz (Australia)
AC 110-120V/220-240V ~ 50/60Hz(Others)
DC 12 V (8 x "C" size or UM-2 batteries)

Specifications subject to change without notice.